

ULTRA HIGH PURITY FITTINGS



METAL GASKET FACE SEAL FITTINGS

				
DNI-R/JSS-R P.008	DNI/JSS P.008	FN P.009	MN P.009	SMN P.009
				
EBF P.010	EBM P.010	EBL P.010	MG.EMC P.011	MG.EM P.011
				
EMCS-AB P.012	EMS-AB P.012	EMC-AB P.013	EM-AB P.013	EMR-AB P.014
				
EFC P.014	RSW P.014	EF P.015	EM P.015	TA P.015
				
MG.EFC P.016	MG.EF P.016	EFR-AB P.016	EFC-AB P.017	EF-AB P.017
				
UM P.018	DMRU P.018	STMC P.018	RA P.019	RB P.019
				
U-FM P.019	CG P.020	UDF P.020	DFRU P.020	U-F P.021
				
UM-NPT P.021	UF-NPT P.021	UM-NPTF P.022	UF-NPTF P.022	UM-DB P.023

METAL GASKET FACE SEAL FITTINGS (continued)



UF-DB P.023



BU-NPT P.024



BU-DB P.024

HIGH FLOW FITTINGS



FN-HF P.024



MN-HF P.025



EM-HF P.025



UM-ABW HF P.025



UM-AB HF P.026



BU-HF P.026

WELD FITTINGS



EB-ABW P.026



RU-ABW P.027



E-ABW P.027



RE-ABW P.027



T-ABW P.028



RT-ABW P.028



C-ABW P.029

DESCRIPTION

GAZEL® METAL GASKET FACE SEAL FITTING

GAZEL® components offer the high purity of a metal to metal seal, providing leak-free service from critical vacuum to high pressure.

The seal on a GAZEL® assembly is made when the gasket is compressed by two highly polished beads during the engagement of a male nut or body hex and a female nut.

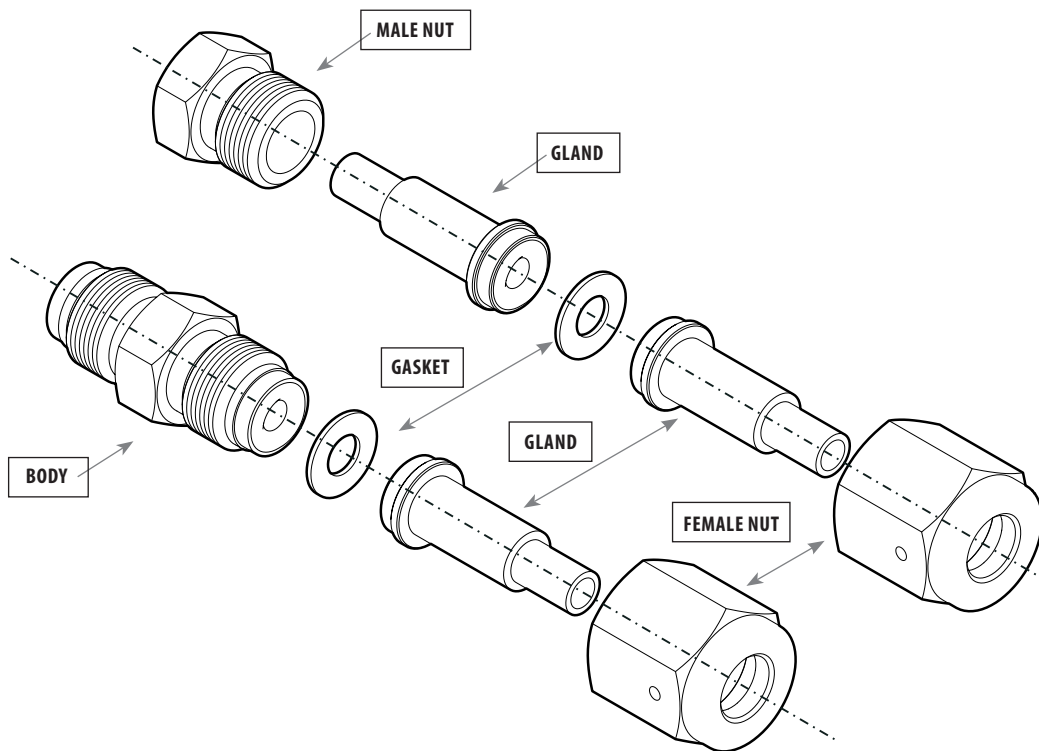
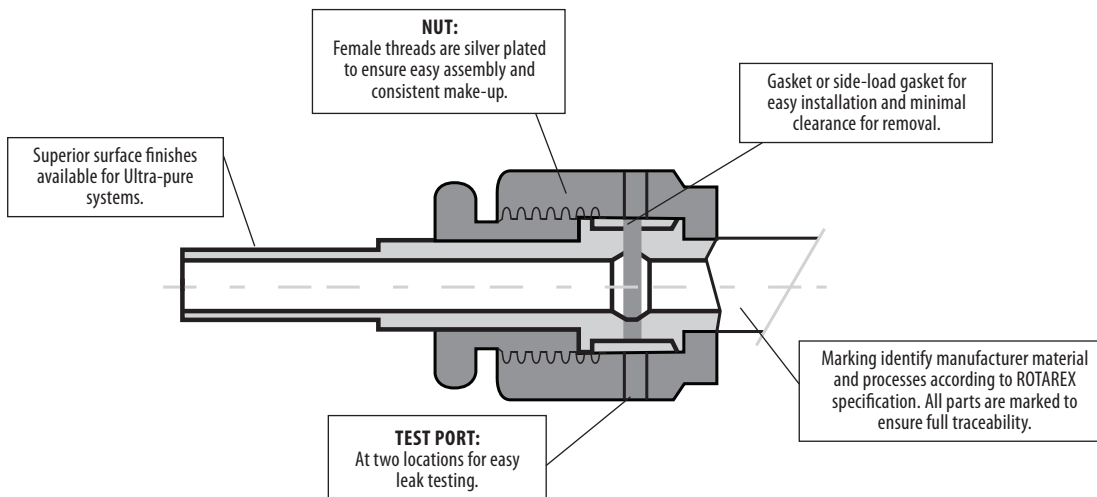

ASSEMBLY

When using an original style gasket, place it into the female nut whenever possible. No special positioning is needed, because the gasket is self-aligning. (see picture 1)

When using a gasket retainer assembly, press the assembly onto the gland as shown. The retainer assembly will locate the gasket over the bead and hold it in place. Be careful not to scratch or nick the bead as this may affect fitting performance. (see picture 2)

To assemble the connection, hold the male nut or body hex stationary. Tighten the female nut finger-tight. (see picture 3)

Hold the male nut or body hex stationary with a backup wrench. Tighten the female nut 1/8 turn past finger-tight for 316L stainless steel and nickel gaskets. (see picture 4)

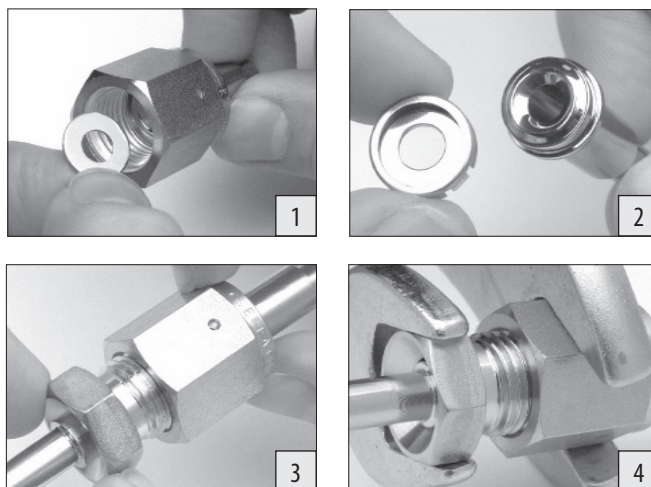

Excessive over-tightening will damage the sealing beads and possibly cause system leakage. The using of a new gasket is necessary for each assembly (the gasket is of single use).

WELD FITTINGS

We provide two types of configurations for the welding section:

- Without shoulder
- With shoulder

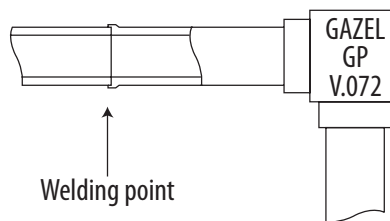
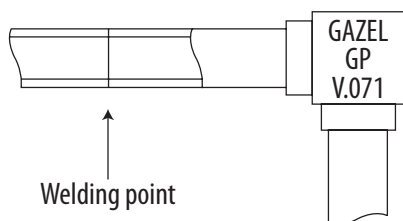

WITHOUT SHOULDER

This is the optimal configuration for butt welding using an automatic TIG welding machine.

WITH SHOULDER

Automatic welding configuration with shoulder to facilitate meeting under difficult welding conditions such as not easily accessible or outside piping.

TECHNICAL DATA

MATERIALS

Products	Material	Specifications
Gasket	Nickel	ASTM B-162
	316L Stainless steel	ASTM A-167
Nuts	316L Stainless steel	ASME SA-479, ASTM A-276
Glands, Bodies	316L Stainless steel low sulfur	Barstock: ASME SA-479, ASTM A-276 Forgings: ASTM A-182

DIMENSIONS

Dimensions are in millimeters and in inches.
Dimensions are only for reference and are subject to change.

Size		Fractional						Metric					Jis	
		1/8"	1/4"	3/8"	1/2"	3/4"	1"	6 mm	8 mm	10 mm	12 mm	18 mm	1/4"	3/8"
Nominal wall thickness	mm	0,71	0,89	0,89	1,25	1,25	1,65	1	1	1	1	1,5	1	1
	inch	0,028	0,035	0,035	0,049	0,049	0,065	0,039	0,039	0,039	0,039	0,059	0,039	0,039
Pressure ratings	psig	5100	5100	3300	3500	2400	2400	6800	4800	3500	3100	3000	5600	3300
	Bar	350	350	220	240	160	160	460	330	240	210	200	380	240

INTERNAL SURFACE FINISH

Grade	Surface finish		Electropolishing
	Ra μ m	Ra μ inch	
GS	0,40	16	Ext.
GP	0,15	5	Int. / Ext. not available for 1/8"

FULL TRACEABILITY

Laser marking identifies manufacturer, batch number, material, processes and surface finish.

TESTING

Gazel fittings has been helium leak tested to a rate of 10^{-10} std cm³/sec.

PRESSURE RATINGS

Pressure ratings are calculated in accordance with power piping code following ASNE B31.1 for stainless steel fittings at ambient temperature.

MAX. TEMPERATURE

Material	Temperature	
	°C	°F
Nickel	315	600
316L Stainless steel low sulfur	537	1000

TECHNICAL DATA

PRODUCT INSPECTION AND TEST

Product inspection

- Dimensional inspection
- Internal and external visual
- Inspection
- Internal roughness measurement

The following tests are carried out at the request of customers:

- ESCA: Electron Spectroscopy for Chemical Analyses
- AES: Argon Electron Spectroscopy
- Corrosion test
- Internal fitting measurement

THREE STAR QUALITY PROCESS

- ISO 9001 Certification
N°:DE-062832 Q1.
- Fully integrated processing (machining, electropolishing, decontamination, packaging, orbital welding).
- Fully traceability at all steps (SPC CAQS).
- Continuous monitoring of key process parameters.

NOMENCLATURE

HOW TO ORDER

- The part number on the fittings data sheets designate the type and the size.
- Just add the material and the surface finish composition symbols shown below.

EXAMPLE:

- For material composition add A, L, V, M, N or H.
- For surface finish add GS or GP.

PART NUMBER



1 Write the reference of the selected fittings (according to tables on each product version)

2 A = 316L Standard
L = 316L Low Sulfur (av. S: 0.005%)
M = Low Manganese (on request)
N = NICKEL
H = Hastelloy® C-22 (on request)

3

Grade	Surface finish		Electropolishing
	Ra μm	Ra μinch	
GS	0,40	16	Ext.
GP	0,15	5	Int. / Ext. not available for 1/8"

	Fractional							Metric				Jis		
	1/16"	1/8"	1/4"	3/8"	1/2"	3/4"	1"	6 mm	8 mm	10 mm	12 mm	18 mm	1/4"	3/8"
Diameter	1/16"	1/8"	1/4"	3/8"	1/2"	3/4"	1"	6 mm	8 mm	10 mm	12 mm	18 mm	1/4"	3/8"
Size Part Number	116	18	14	38	12	34	100	6M	8M	10M	12M	18M	14J	38J

GASKET | NICKEL GASKET & RETAINER

TUBE SIZE

Tube O.D.	Part number	L		d		D	
		mm	inch	mm	inch	mm	inch
¼", 6 mm, 8 mm	DNI 14 R ³	0,7	0,03	6,1	0,24	12,7	0,50
⅜", ½", 10 mm, 12 mm	DNI 12 R ³	0,7	0,03	11,2	0,44	20,1	0,79
¾", 18 mm	DNI 34 R	0,7	0,03	16,8	0,66	29,0	1,14
1"	DNI 100 R	0,7	0,03	22,6	0,89	25,6	1,40

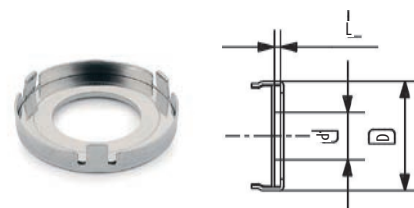

GASKET | NICKEL

TUBE SIZE

Tube O.D.	Part number	L		d		D	
		mm	inch	mm	inch	mm	inch
⅛"	DNI 18 ¹	0,5	0,02	2,3	0,09	6,6	0,26
¼", 6 mm, 8 mm	DNI 14 ¹	0,7	0,03	6,1	0,24	11,9	0,47
⅜", ½", 10 mm, 12 mm	DNI 12 ¹	0,7	0,03	11,2	0,44	19,8	1,78
¾", 18 mm	DNI 34 ¹	0,7	0,03	16,8	0,66	29,0	1,14
1"	DNI 100 ¹	0,7	0,03	22,6	0,89	35,6	1,40

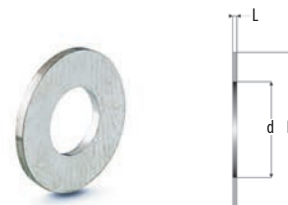

GASKET | SILVER PLATED 316L

TUBE SIZE

Tube O.D.	Part number	L		d		D	
		mm	inch	mm	inch	mm	inch
⅛"	JSS 18	0,5	0,02	2,3	0,09	6,6	0,26
¼", 6 mm, 8 mm	JSS 14 ^{1,2}	0,7	0,03	6,1	0,24	11,9	0,47
⅜", ½", 10 mm, 12 mm	JSS 12 ¹	0,7	0,03	11,2	0,44	19,8	1,78
¾", 18 mm	JSS 34 ¹	0,7	0,03	16,8	0,66	29,0	1,14
1"	JSS 100 ¹	0,7	0,03	22,6	0,89	35,6	1,40



¹ On request: for silver plated Nickel, use the prefix JNI (Example: JNI 14)

² On request: blind gasket, use part number JSS 14 EB

³ On request in stainless steel, use the prefix JSS (Example: JSS 14 R)

NUTS | FEMALE NUT

TUBE SIZE

Tube O.D.	Part number	L		d		F
		mm	inch	mm	inch	mm
1/8"	FN 18	13,5	0,53	5,3	0,21	11,1
1/4", 6 mm, 8 mm	FN 14	20,6	0,81	9,1	0,36	19,1
3/8", 1/2", 10 mm, 12 mm	FN 12	22,4	0,88	15,5	0,61	27,0
3/4", 18 mm	FN 34	28,4	1,12	22,6	0,89	38,1
1"	FN 100	34,0	1,34	30,5	1,20	44,5

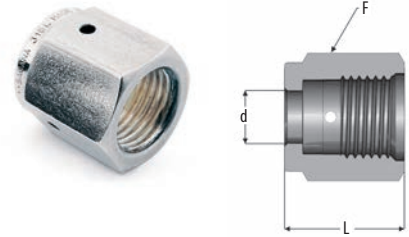

NUTS | MALE NUT

TUBE SIZE

Tube O.D.	Part number	L		d		F
		mm	inch	mm	inch	mm
1/8"	MN 18	12,7	0,50	5,3	0,21	9,5
1/4", 6 mm, 8 mm	MN 14 ¹	18,0	0,71	9,1	0,36	15,9
3/8", 1/2", 10 mm, 12 mm	MN 12	20,6	0,81	15,5	0,61	23,8
3/4", 18 mm	MN 34	25,4	1,00	22,6	0,89	33,3
1"	MN 100	30,2	1,19	30,5	1,20	41,3

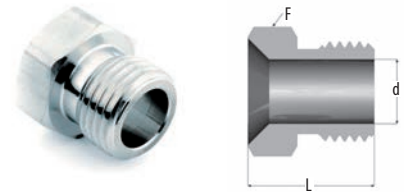

NUTS | SHORT MALE NUT

TUBE SIZE

Tube O.D.	Part number	L		d		F
		mm	inch	mm	inch	mm
1/4", 6 mm, 8 mm	SMN 14	13,7	0,54	9,1	0,36	15,9
1/4", 6 mm, 8 mm	SMN 14.6	16,5	0,65	9,1	0,36	15,9

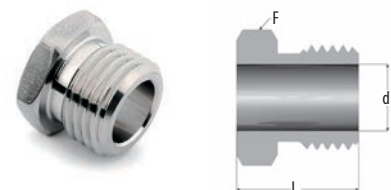

¹ A taper at the hex allows the nut to move around 90° tube bends

PLUGS | FEMALE CAP

TUBE SIZE

Tube O.D.	Part number	L		L1		F
		mm	inch	mm	inch	
¼", 6 mm, 8 mm	EBF 14 ¹	23,9	0,94	11,2	0,44	19,1
⅜", ½", 10 mm, 12 mm	EBF 12 ¹	25,6	1,01	11,4	0,45	27,0
¾", 18 mm	EBF 34	32,8	1,29	13,7	0,54	38,1
1"	EBF 100	39,1	1,54	16,0	0,63	44,5

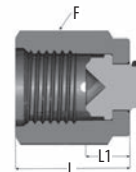

PLUGS | MALE PLUG

TUBE SIZE

Tube O.D.	Part number	L		F
		mm	inch	
⅛"	EBM 18	17,3	0,68	9,5
¼", 6 mm, 8 mm	EBM 14 ^{2,3}	23,4	0,92	15,9
⅜", ½", 10 mm, 12 mm	EBM 12 ³	27,4	1,08	23,8
¾", 18 mm	EBM 34	36,3	1,43	33,3
1"	EBM 100	38,6	1,52	41,3

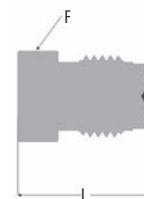

PLUGS | GLAND PLUG

TUBE SIZE

Tube O.D.	Part number	L	
		mm	inch
⅛"	ELB 18	17,8	0,70
¼", 6 mm, 8 mm	ELB 14 ⁴	33,3	1,31
⅜", ½", 10 mm, 12 mm	ELB 12	38,1	1,50
¾", 18 mm	ELB 34	50,8	2,00
1"	ELB 100	56,4	2,22



¹ On request with lanyard, use EBFL as a part number (Example: EBFL 14)

² Also available as a rotatable plug. Ordering number: EBMR 14

³ On request with lanyard, use EBML as a part number (Example: EBML 14)

⁴ On request it can be delivered with L = 19.0 (0.75") Part number: EB 14

GLANDS | MINI SHORT FEMALE GLAND

TUBE SIZE

Tube O.D.	Part number	L		d		C		Nominal Wall Thickness		Working Pressure	
		mm	inch	mm	inch	mm	inch	mm	inch	psig	bar
FRACTIONAL											
¼"	MG.EMC 14	15,2	0,60	4,6	0,18	6,4	0,25	0,89	0,035	5100	350
⅜"	MG.EMC 38	15,7	0,62	7,7	0,30	6,4	0,25	0,89	0,035	3300	220
½"	MG.EMC 12	15,7	0,62	10,2	0,40	6,4	0,25	1,25	0,049	3500	240
METRIC											
6 mm	MG.EMC 6M	15,2	0,60	4,0	0,16	6,4	0,25	1,0	0,039	6800	460
8 mm	MG.EMC 8M	15,7	0,62	6,0	0,24	6,4	0,25	1,0	0,039	4800	330
JIS											
¼"	MG.EMC 14J	15,2	0,60	4,4	0,17	6,4	0,25	1,0	0,039	5600	380
⅜"	MG.EMC 38J	15,7	0,62	7,5	0,39	6,4	0,25	1,0	0,039	3500	240

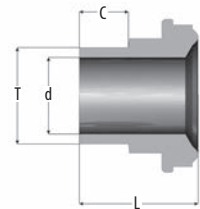

GLANDS | MINI MALE GLAND

TUBE SIZE

Tube O.D.	Part number	L		d		C		Nominal Wall Thickness		Working Pressure	
		mm	inch	mm	inch	mm	inch	mm	inch	psig	bar
FRACTIONAL											
⅛"	MG.EM 18	23,4	0,92	2,1	0,08	6,4	0,25	0,71	0,028	5100	350
¼"	MG.EM 14	30,5	1,20	4,6	0,18	6,4	0,25	0,89	0,035	3300	220
⅜"	MG.EM 38	32,8	1,29	7,7	0,30	6,4	0,25	0,89	0,035	3300	240
½"	MG.EM 12	32,8	1,29	10,2	0,40	6,4	0,25	1,25	0,049	3500	240
METRIC											
6 mm	MG.EM 6M	30,5	1,20	4,0	0,16	6,4	0,25	1,0	0,039	6800	460
JIS											
¼"	MG.EM 14J	30,5	1,20	4,4	0,17	6,4	0,25	1,0	0,039	5600	380
⅜"	MG.EM 38J	32,8	1,29	7,5	0,29	6,4	0,25	1,0	0,039	3500	240

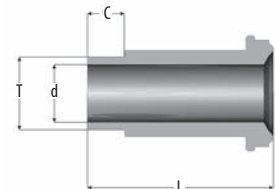

GLANDS | AUTOMATIC TUBE WELD SHORT FEMALE GLAND

TUBE SIZE

Tube O.D.	Part number	L		d		C		Nominal Wall Thickness		Working Pressure	
		mm	inch	mm	inch	mm	inch	mm	inch	psig	bar
FRACTIONAL											
¼"	EMCS 14 AB	18,3	0,72	4,6	0,18	9,6	0,38	0,89	0,035	5100	350
½"	EMCS 12 AB	18,8	0,74	10,2	0,40	9,6	0,38	1,25	0,049	3500	240
JIS											
¼"	EMCS 14J AB	18,3	0,72	4,4	0,17	9,6	0,38	1,0	0,039	5600	380
⅜"	EMCS 38J AB	18,8	0,74	7,5	0,29	9,6	0,38	1,0	0,039	3500	240

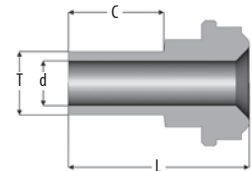

GLANDS | AUTOMATIC TUBE WELD MALE GLAND

TUBE SIZE

Tube O.D.	Part number	L		d		C		Nominal Wall Thickness		Working Pressure	
		mm	inch	mm	inch	mm	inch	mm	inch	psig	bar
FRACTIONAL											
¼"	EMCA 14 AB	33,3	1,31	4,6	0,18	9,1	0,36	0,89	0,035	5100	350
¼"	EMS 14 AB	33,5	1,32	4,6	0,18	9,6	0,38	0,89	0,035	5100	350
½"	EMS 12 AB	38,8	1,33	10,2	0,40	9,6	0,38	1,25	0,049	3500	240
JIS											
¼"	EMS 14J AB	33,5	1,32	4,4	0,17	9,6	0,38	1,0	0,039	5600	380
⅜"	EMS 38J AB	35,8	1,41	7,5	0,29	9,6	0,38	1,0	0,039	3500	240

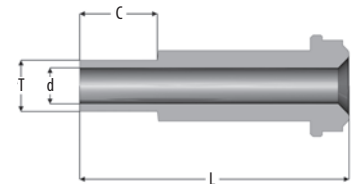

GLANDS | AUTOMATIC TUBE WELD SHORT FEMALE GLAND

TUBE SIZE

Tube O.D.	Part number	L		d		C		Nominal Wall Thickness		Working Pressure	
		mm	inch	mm	inch	mm	inch	mm	inch	psig	bar
FRACTIONAL											
½"	EMC 18 AB	27,4	1,08	2,1	0,08	19,1	0,75	0,71	0,028	5100	350
¼"	EMC 14 AB	27,9	1,10	4,6	0,18	19,1	0,75	0,89	0,035	5100	350
⅜"	EMC 38 AB	28,4	1,12	7,7	0,30	19,1	0,75	0,89	0,035	3300	220
½"	EMC 12 AB	28,4	1,12	10,2	0,40	19,1	0,75	1,25	0,049	3500	240
METRIC											
6 mm	EMC 6M AB	29,5	1,16	4,0	0,16	19,1	0,75	1,0	0,039	6800	460
8 mm	EMC 8M AB	29,5	1,16	6,0	0,24	19,1	0,75	1,0	0,039	4800	330
10 mm	EMC 10M AB	29,5	1,16	8,0	0,31	19,1	0,75	1,0	0,039	3500	240
12 mm	EMC 12M AB	29,5	1,16	10,0	0,39	19,1	0,75	1,0	0,039	3100	210
18 mm	EMC 18M AB	31,0	1,22	15,0	0,59	19,1	0,75	1,5	0,059	3000	200
JIS											
¼"	EMC 14J AB	27,9	1,10	4,4	0,17	19,1	0,75	1,0	0,039	5600	380
⅜"	EMC 38J AB	28,4	1,12	7,5	0,29	19,1	0,75	1,0	0,039	3300	240

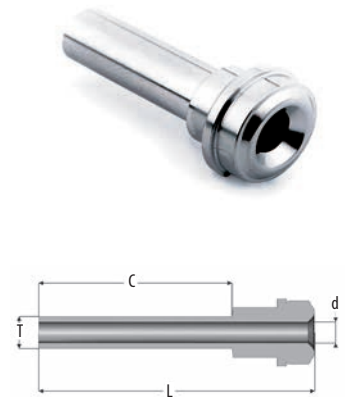

GLANDS | AUTOMATIC TUBE WELD MALE GLAND

TUBE SIZE

Tube O.D.	Part number	L		d		C		Nominal Wall Thickness		Working Pressure	
		mm	inch	mm	inch	mm	inch	mm	inch	psig	bar
FRACTIONAL											
⅝"	EM 18 AB	36,1	1,42	2,1	0,08	19,1	0,75	0,71	0,028	5100	350
¼"	EM 14 AB	43,2	1,70	4,6	0,18	19,1	0,75	0,89	0,035	5100	350
⅜"	EM 38 AB	45,5	1,79	7,7	0,30	19,1	0,75	0,89	0,035	3300	220
½"	EM 12 AB	45,5	1,79	10,2	0,40	19,1	0,75	1,25	0,049	3500	240
¾"	EM 34 AB	51,6	2,03	16,5	0,65	19,1	0,75	1,25	0,049	2400	160
1"	EM 100 AB	58,9	2,32	22,1	0,87	19,1	0,75	1,65	0,065	2400	160
METRIC											
6 mm	EM 6M AB	43,1	1,70	4,0	0,16	19,1	0,75	1,0	0,039	6800	460
8 mm	EM 8M AB	43,1	1,70	6,0	0,24	19,1	0,75	1,0	0,039	4800	330
10 mm	EM 10M AB	45,5	1,79	8,0	0,31	19,1	0,75	1,0	0,039	3500	240
12 mm	EM 12M AB	45,5	1,79	10,0	0,39	19,1	0,75	1,0	0,039	3100	210
18 mm	EM 18M AB	51,6	2,03	15,0	0,59	19,1	0,75	2,5	0,059	3100	200
JIS											
¼"	EM 14J AB	43,2	1,70	4,4	0,17	19,1	0,75	1,0	0,039	5600	380
⅜"	EM 38J AB	45,5	1,79	7,5	0,29	19,1	0,75	1,0	0,039	3300	240

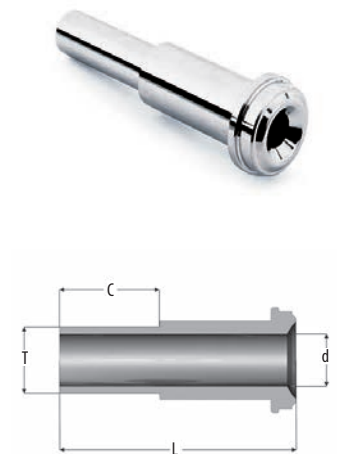

GLANDS | AUTOMATIC TUBE WELD REDUCING MALE GLAND

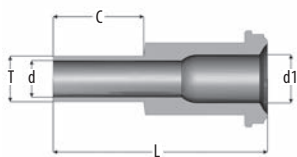

TUBE SIZE - FRACTIONAL

T1 Tube O.D.	T Tube O.D.	Part number	L		d1		d		C		Nominal Wall Thickness		Working Pressure	
			mm	inch	mm	inch	mm	inch	mm	inch	mm	inch	psig	bar
1/2"	1/4"	EMR 12 14 AB	45,5	1,79	10,2	0,40	4,6	0,18	19,1	0,75	0,89	0,035	3500	240
1/2"	3/8"	EMR 12 38 AB	45,5	1,79	10,2	0,40	7,7	0,30	19,1	0,75	0,89	0,035	3300	220
1/2"	1/4"	EMCR 12 14 AB	28,4	1,12	10,2	0,40	4,6	0,18	19,1	0,75	0,89	0,035	3500	240
1/2"	3/8"	EMCR 12 38 AB	28,4	1,12	10,2	0,40	7,7	0,30	19,1	0,75	0,89	0,035	3300	220

GLANDS | SHORT SOCKET WELD GLAND

TUBE SIZE - FRACTIONAL

T Tube O.D.	Part number	L		d		B	Working Pressure	
		mm	inch	mm	inch		mm	psig
1/4"	EFCS 14	12,7	0,50	4,6	0,18	7,9	5500	370
1/4"	EFC 14	19,1	0,75	4,6	0,18	7,1	5500	370

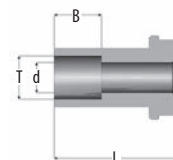

GLANDS | REDUCING SOCKET WELD GLAND

TUBE SIZE - FRACTIONAL

T1 Tube O.D.	T Tube O.D.	Part number	L		d1		d		B	Working Pressure	
			mm	inch	mm	inch	mm	inch		mm	psig
1/4"	1/8"	RSW 14 18	33,3	1,31	4,6	0,18	2,1	0,08	2,5	8000	550
1/2"	1/4"	RSW 12 14	38,0	1,50	10,2	0,40	4,6	0,18	7,1	3500	240

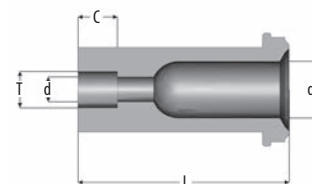

GLANDS | SOCKET WELD GLAND

TUBE SIZE - FRACTIONAL

T Tube O.D.	Part number	L		d		D	B	Working Pressure	
		mm	inch	mm	inch			psig	bar
1/16"	EF 116 ^{1,2}	17,8	0,70	1,5	0,06	3,3	2,5	9000	620
1/8"	EF 18	17,8	0,70	2,1	0,08	5,1	2,5	7100	480
1/4"	EF 14	33,3	1,31	4,6	0,18	8,9	7,1	5500	370
3/8"	EF 38	38,1	1,50	7,7	0,30	15,2	8,0	3500	240
1/2"	EF 12	38,1	1,50	10,2	0,40	15,2	9,6	3000	200
3/4"	EF 34	50,8	2,00	16,5	0,65	22,4	11,2	2800	190
1"	EF 100	56,4	2,22	22,1	0,87	30,2	15,7	2400	160

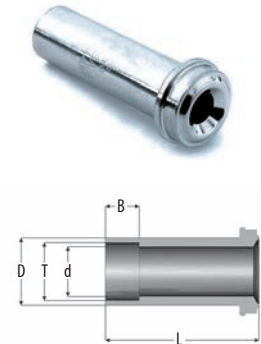

GLANDS | MALE WELD GLAND

TUBE SIZE - FRACTIONAL

T1 Tube O.D.	T Tube O.D.	Part number	L		d		d1		C		Working Pressure	
			mm	inch	mm	inch	mm	inch	mm	inch	psig	bar
1/8"	1/8"	EM 18	17,8	0,70	1,5	0,06	2,1	0,08	7,1	0,28	9000	620
1/4"	1/8"	EMR 14 18	33,3	1,31	1,5	0,06	2,1	0,08	7,1	0,28	8000	550
1/4"	1/4"	EM 14	33,3	1,31	3,0	0,12	4,6	0,18	10,4	0,41	8000	550
1/2"	1/4"	EMR 12 14	38,1	1,50	3,0	0,12	4,6	0,18	10,4	0,41	3500	240
1/2"	3/8"	EM 38	38,1	1,50	7,1	0,28	7,7	0,30	10,4	0,41	3500	240
1/2"	1/2"	EM 12	38,1	1,50	10,2	0,40	10,2	0,40	12,7	0,50	3500	240
3/4"	3/4"	EM 34	50,8	2,00	13,5	0,53	16,5	0,65	15,7	0,62	3000	200
1"	1"	EM 100	56,4	2,22	19,1	0,75	22,1	0,87	20,6	0,81	2400	160

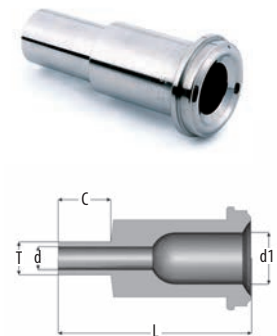

GLANDS | TUBE ADAPTER

TUBE SIZE - FRACTIONAL

T1 Tube O.D.	Part number	L		d		C		Working Pressure	
		mm	inch	mm	inch	mm	inch	psig	bar
1/4"	TA 14	41,0	1,61	4,6	0,18	16,2	0,64	2400	160
3/8"	TA 38	46,0	1,81	7,7	0,30	17,8	0,70	1500	100
1/2"	TA 12	49,3	1,94	10,2	0,40	24,4	0,96	1500	100

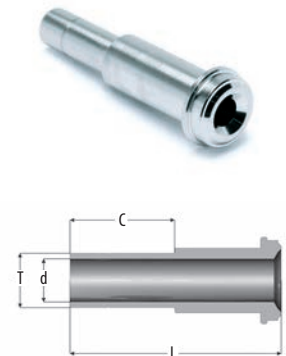

1) Use DNI 18 and FN 18 or MN 18
2) Minimum quantity

GLANDS | MINI SHORT FEMALE GLAND

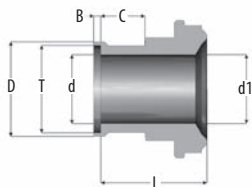

TUBE SIZE - FRACTIONAL

T1 Tube O.D.	T Tube O.D.	Part number	L		d1		d		D	B	C		Nominal Wall Thickness		Working Pressure	
			mm	inch	mm	inch	mm	inch			mm	inch	mm	inch	psig	bar
1/4"	1/8"	MG.EFC 14 18	15,6	0,61	4,6	0,18	2,1	0,08	3,8	0,3	6,4	0,25	0,71	0,028	5100	350
1/4"	1/4"	MG.EFC 14	15,7	0,62	4,6	0,18	4,6	0,18	7,4	0,5	6,4	0,25	0,89	0,035	5100	350
3/8"	3/8"	MG.EFC 38	16,5	0,65	7,7	0,30	7,7	0,30	10,5	0,8	6,4	0,25	0,89	0,035	3300	220
1/2"	1/2"	MG.EFC 12	16,7	0,66	10,2	0,40	10,2	0,40	14,0	1,0	6,4	0,25	1,25	0,049	3500	240

GLANDS | MINI MALE GLAND

TUBE SIZE - FRACTIONAL

T Tube O.D.	Part number	L		d		D	B	C		Nominal Wall Thickness		Working Pressure	
		mm	inch	mm	inch			mm	inch	mm	inch	psig	bar
1/8"	MG.EF 18	23,8	0,94	2,1	0,08	3,8	0,5	6,4	0,25	0,71	0,028	5100	350
1/4"	MG.EF 14	31,0	1,22	4,6	0,18	7,4	0,5	6,4	0,25	0,89	0,035	5100	350
1/2"	MG.EF 12	33,8	1,33	10,2	0,40	14,0	1,0	6,4	0,25	1,3	0,049	3500	240

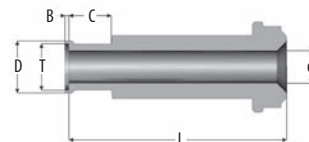

GLANDS | AUTOMATIC TUBE WELD REDUCING GLAND

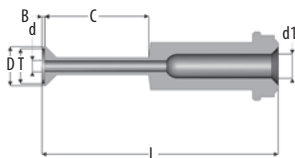

TUBE SIZE - FRACTIONAL

T Tube O.D.	Part number	L		d1		d		D	B	C		Nominal Wall Thickness		Working Pressure	
		mm	inch	mm	inch	mm	inch			mm	inch	mm	inch	psig	bar
1/4"	EFR 14 18 AB	43,5	1,71	4,6	0,18	2,1	0,08	3,8	0,5	19,1	0,75	0,71	0,028	5100	350
1/4"	EFCR 14 18 AB	28,2	1,11	4,6	0,18	2,1	0,08	3,8	0,5	19,1	0,75	0,71	0,028	5100	350
1/2"	EFR 12 14 AB	46,2	1,82	10,2	0,40	4,6	0,18	7,4	0,5	19,1	0,75	0,89	0,035	3500	240
1/2"	EFR 12 38 AB	46,2	1,82	10,2	0,40	7,7	0,30	14,0	0,8	19,1	0,75	0,89	0,035	3500	240

GLANDS | AUTOMATIC TUBE WELD SHORT FEMALE GLAND

TUBE SIZE

T Tube O.D.	Part number	L		d		D	B	C		Nominal Wall Thickness		Working Pressure	
		mm	inch	mm	inch	mm	mm	mm	inch	mm	inch	psig	bar
FRACTIONAL													
¼"	EFC 14 AB	28,4	1,12	4,6	0,18	7,4	0,5	19,1	0,75	0,89	0,035	5100	350
⅜"	EFC 38 AB	29,2	1,15	7,7	0,30	10,5	0,8	19,1	0,75	0,89	0,035	3300	220
½"	EFC 12 AB	29,5	1,16	10,2	0,40	14,0	1,0	19,1	0,75	1,25	0,049	3500	240
METRIC													
6 mm	EFC 6M AB	30,0	1,18	4,0	0,16	6,9	0,5	19,1	0,75	1,0	0,039	6800	460
8 mm	EFC 8M AB	30,2	1,19	6,0	0,24	8,9	0,8	19,1	0,75	1,0	0,039	4800	330
10 mm	EFC 10M AB	31,0	1,22	8,0	0,31	10,9	0,8	19,1	0,75	1,0	0,039	3500	240
12 mm	EFC 12M AB	30,5	1,20	10,0	0,39	13,2	1,0	19,1	0,75	1,0	0,039	3100	210
JIS													
¼"	EFC 14J AB	43,7	1,72	4,4	0,17	7,4	0,5	19,1	0,75	1,0	0,039	5600	380
⅜"	EFC 38J AB	46,2	1,82	7,5	0,29	10,5	0,8	19,1	0,75	1,0	0,039	3500	240

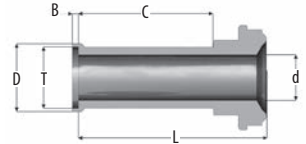

GLANDS | AUTOMATIC TUBE WELD MALE GLAND

TUBE SIZE

T Tube O.D.	Part number	L		d		D	B	C		Nominal Wall Thickness		Working Pressure	
		mm	inch	mm	inch	mm	mm	mm	inch	mm	inch	psig	bar
FRACTIONAL													
¼"	EF 14 AB	43,7	1,72	4,6	0,18	7,4	0,5	19,1	0,75	0,89	0,035	5100	350
⅜"	EF 38 AB	46,2	1,82	7,7	0,30	10,5	0,8	19,1	0,75	0,89	0,035	3300	220
½"	EF 12 AB	46,5	1,83	10,2	0,40	14,0	1,0	19,1	0,75	1,25	0,049	3500	240
¾"	EF 34 AB	52,6	2,07	16,5	0,65	20,3	1,0	19,1	0,75	1,25	0,049	2400	160
½"	EF 100 AB	65,3	2,57	22,1	0,87	26,9	1,0	24,4	0,75	1,65	0,065	2400	160
METRIC													
6 mm	EF 6M AB	43,7	1,72	4,0	0,16	6,9	0,5	19,1	0,75	1,0	0,039	6800	460
8 mm	EF 8M AB	44,0	1,73	6,0	0,24	8,9	0,8	19,1	0,75	1,0	0,039	4800	330
12 mm	EF 12M AB	46,5	1,83	10,0	0,39	13,2	1,0	19,1	0,75	1,0	0,039	3500	240
18 mm	EF 18M AB	52,6	2,07	15,0	0,59	19,2	1,0	19,1	0,75	1,5	0,059	3100	210
JIS													
¼"	EF 14J AB	43,7	1,72	4,4	0,17	7,4	0,5	19,1	0,75	1,0	0,039	5600	380
⅜"	EF 38J AB	46,2	1,83	7,5	0,29	10,5	0,8	19,1	0,75	1,0	0,039	3500	240

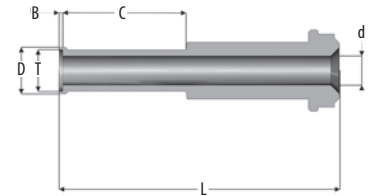

UNIONS | DOUBLE MALE UNION

TUBE SIZE - FRACTIONAL

T Tube O.D.	Part number	L		d		F		Working Pressure	
		mm	inch	mm	inch	mm	inch	psig	bar
1/8"	UM 18 ¹	28,7	1,13	2,1	0,08	9,5	0,37	9000	620
1/4"	UM 14 ¹	39,4	1,55	4,6	0,18	15,9	0,63	8000	550
1/2"	UM 12 ¹	46,7	1,84	10,2	0,40	23,8	0,94	3500	240
3/4"	UM 34 ¹	62,0	2,44	16,5	0,65	33,3	1,31	3000	200
1"	UM 100 ¹	65,8	2,59	22,1	0,87	41,3	1,63	2400	160

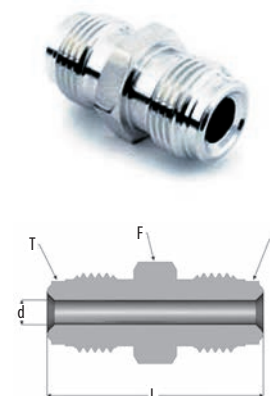

UNIONS | DOUBLE MALE REDUCING UNION

TUBE SIZE - FRACTIONAL

T1 Tube O.D.	T Tube O.D.	Part number	L		d1		d		F		Working Pressure	
			mm	inch	mm	inch	mm	inch	mm	inch	psig	bar
1/4"	1/8"	DMRU 14 18 ¹	34,8	1,37	2,1	0,08	4,6	0,18	15,9	0,63	8000	550
1/2"	1/4"	DMRU 12 14 ¹	43,4	1,71	4,6	0,18	10,2	0,40	23,8	0,94	3500	240

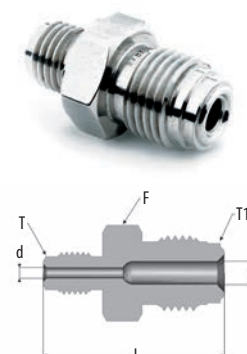

UNIONS | STRAIGHT THREAD MALE CONNECTOR, O-RING

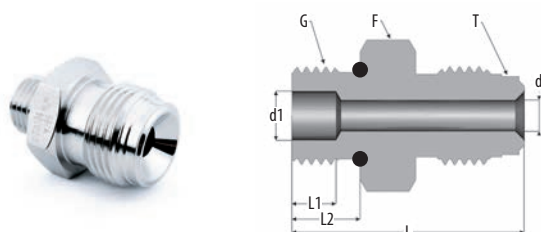

TUBE SIZE - FRACTIONAL

T Tube O.D.	Part number	L		L1	L2	d1		d		F	G	O-ring Size N°	Working Pressure	
		mm	inch			mm	inch	mm	inch				psig	bar
1/4"	STMC 14 ^{1,2}	33,8	1,33	6,4	9,9	7,1	0,28	4,6	0,18	19,1	9-16"-18	FLUOROCARBON 906	4500	310
1/2"	STMC 12 12 ^{1,2}	42,2	1,66	10,2	12,7	15	0,59	7,1	0,28	25,4	7/8"-14	FLUOROCARBON 910	3500	240
1/2"	STMC 12 14 ^{1,2}	37,6	1,48	6,4	9,9	7,1	0,28	7,1	0,28	23,8	3/4"-18	FLUOROCARBON 906	3500	240

1) These fittings should be assembled only with rotating male or female nuts
2) O-rings fluorocarbon FKM standard, other materials on request

UNIONS | REDUCING ADAPTER

TUBE SIZE - FRACTIONAL

T1 Tube O.D.	T Tube O.D.	Part number	L		L1	d		F		Working Pressure	
			mm	inch		mm	inch	mm	psig	bar	
¼"	⅛"	RA 14 18 ¹	30,2	1,19	17,5	2,1	0,08	19,1	8000	550	
½"	¼"	RA 12 14 ¹	35,8	1,41	21,6	4,6	0,18	27,0	3500	240	

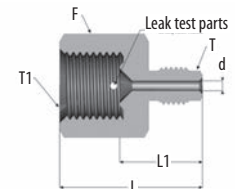

UNIONS | REDUCING ADAPTER

TUBE SIZE - FRACTIONAL

T1 Tube O.D.	T Tube O.D.	Part number	L		L1	d		F		Working Pressure	
			mm	inch		mm	inch	mm	psig	bar	
¼"	⅛"	RB 14 18 ¹	36,9	1,06	19,3	3,6	0,14	15,9	8000	550	
½"	¼"	RB 12 14 ¹	35,8	1,41	23,1	6,3	0,25	23,8	3500	240	

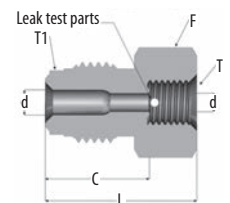

UNIONS | MALE FEMALE UNION

TUBE SIZE - FRACTIONAL

T Tube O.D.	Part number	L		d		F	F1	Working Pressure	
		mm	inch	mm	inch			psig	bar
¼"	U 14 FM ¹	43,4	1,71	4,6	0,18	15,9	19,1	5100	350

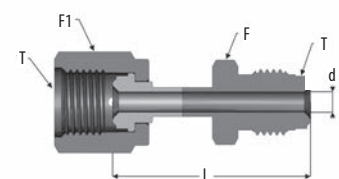

1) These fittings should be assembled only with rotating male or female nuts

UNIONS | COUPLING

TUBE SIZE - FRACTIONAL

T Tube O.D.	Part number	L		F
		mm	inch	mm
1/8"	CG 18 ¹	16,8	0,66	11,1
1/4"	CG 14 ¹	30,2	1,19	19,1
1/2"	CG 12 ¹	33,3	1,31	27,0
3/4"	CG 34 ¹	42,7	1,68	38,1
1"	CG 100 ¹	51,8	2,04	44,5

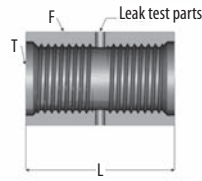

UNIONS | DOUBLE FEMALE UNION

TUBE SIZE - FRACTIONAL

T Tube O.D.	Part number	L		L1	d	F	Working Pressure	
		mm	inch	mm	mm	mm	psig	bar
1/4"	UDF 14	30,2	1,19	4,9	5,9	19	8000	550
1/4"	UDF 14 HF	30,2	1,19	4,9	6,4	19	8000	550
1/2"	UDF 12	33,3	1,31	4,9	10,2	27	3500	240

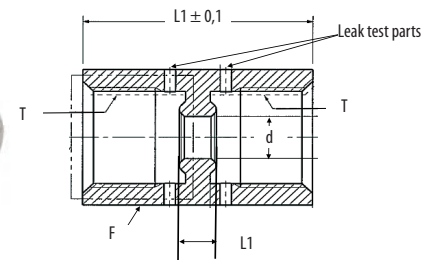

UNIONS | DOUBLE FEMALE REDUCING UNION

TUBE SIZE - FRACTIONAL

T1 Tube O.D.	T Tube O.D.	Part number	L		L1	d		F	Working Pressure	
			mm	inch	mm	mm	inch	mm	psig	bar
1/4"	1/8"	DFRU 14 18 ¹	29,5	1,16	9,1	3,3	0,13	19,1	8000	550
1/2"	1/4"	DFRU 12 14 ¹	35,8	1,41	8,9	6,3	0,25	27,0	3500	240

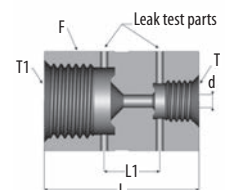

1) These fittings should be assembled only with rotating male or female nuts
 2) On request it can be delivered with a double female, reducing union 1/2" F and 1/4" F (Part number UR 12 14 F)

UNIONS | DOUBLE FEMALE UNION

TUBE SIZE - FRACTIONAL

T Tube O.D.	Part number	L		d		F	Working Pressure	
		mm	inch	mm	inch		mm	psig
1/4"	U 14 F ²	43,4	1,71	4,6	0,18	19,1	5100	350
1/2"	U 12 F ²	46,7	1,84	10,2	0,40	27,0	3500	240

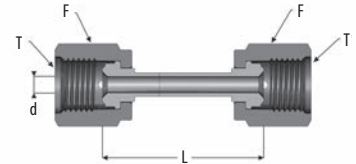

UNIONS | MALE CONNECTOR

TUBE SIZE - FRACTIONAL

T Tube O.D.	P NPT	Part number	L		L1	d		F	Working Pressure	
			mm	inch		mm	mm		mm	psig
1/8"	1/16"	UM 18 NPT 116 ^{1,2}	27,2	1,07	9,6	2,1	0,08	9,5	9000	620
1/8"	1/8"	NPT 18 ¹	27,2	1,07	9,6	2,1	0,08	9,5	9000	620
1/4"	1/8"	UM 14 NPT 18 ¹	33,3	1,31	9,6	4,6	0,18	15,9	8000	550
1/4"	1/4"	NPT 14 ¹	37,8	1,49	14,2	4,6	0,18	15,9	8000	550
1/2"	3/8"	UM 12 NPT 38 ¹	41,9	1,65	14,2	9,7	0,38	23,8	3500	240
1/2"	1/2"	NPT 12 ¹	46,7	1,84	19,1	10,2	0,40	23,8	3500	240
3/4"	3/4"	NPT 34 ¹	55,6	2,19	19,1	15,8	0,62	33,3	3000	200
1"	1"	NPT 100 ¹	62,7	2,47	22,3	22,3	0,88	41,3	2400	160

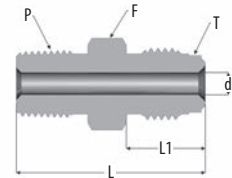

UNIONS | FEMALE CONNECTOR

TUBE SIZE - FRACTIONAL

T Tube O.D.	T Tube O.D.	Part number	L		L1	L2	d		F	F1	Working Pressure	
			mm	inch			mm	mm			mm	mm
1/4"	1/8"	UF 14 NPT 18	40,1	1,58	9,6	24,1	4,6	0,18	15,9	19,1	5100	350
1/4"	1/4"	NPT 14 F	45,5	1,79	14,2	23,4	4,6	0,18	15,9	19,1	5100	350
1/2"	3/8"	UF 12 NPT 38	48,0	1,89	14,2	25,4	9,9	0,39	23,8	27,0	3500	240
1/2"	1/2"	NPT 12 F	53,1	2,09	19,1	25,6	9,9	0,39	23,8	27,0	3500	240

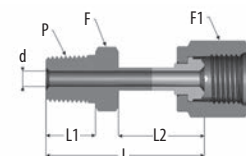

1) These fittings should be assembled only with rotating male or female nuts
2) Minimum quantity

UNIONS | FEMALE CONNECTOR

TUBE SIZE - FRACTIONAL

T Tube O.D.	P NPT	Part number	L		d		F	Working Pressure	
			mm	inch	mm	inch		mm	psig
1/8"	1/16"	UM 18 NPTF 116 ¹	27,9	1,10	2,3	0,09	11,1	6700	460
1/8"	1/8"	UM 18 NPTF 18 ¹	30,2	1,19	2,3	0,09	14,3	6500	440
1/4"	1/8"	UM 14 NPTF 18 ¹	35,8	1,41	4,6	0,18	15,9	8000	550
1/4"	1/4"	UM 14 NPTF 14 ¹	39,1	1,54	4,6	0,18	19,1	6600	450
1/2"	3/8"	UM 12 NPTF 38 ¹	44,7	1,76	10,2	0,40	23,8	3500	240
1/2"	1/2"	UM 12 NPTF 12 ¹	50,5	1,99	10,2	0,40	27,0	3500	240
3/4"	3/4"	UM 34 NPTF 34 ¹	59,7	2,36	15,7	0,62	33,3	3000	200
1"	1"	UM 100 NPTF 100 ¹	63,8	2,51	22,1	0,87	41,3	2400	160

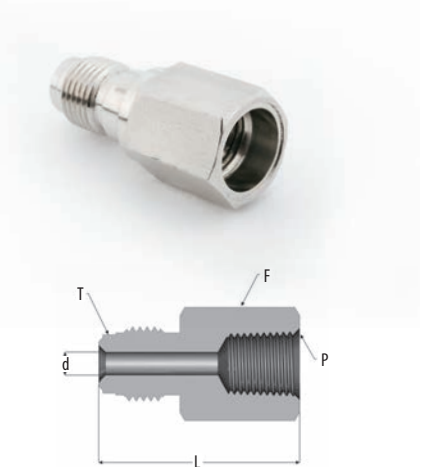

UNIONS | FEMALE CONNECTOR

TUBE SIZE - FRACTIONAL

T Tube O.D.	P NPT	Part number	L		L1	d		F	F1	Working Pressure	
			mm	inch		mm	inch			mm	mm
1/4"	1/4"	UF 14 NPTF 14	45,2	1,78	23,4	4,6	0,18	19,1	19,1	5100	350
1/2"	3/8"	UF 12 NPTF 38	49,5	1,95	26,9	10,2	0,40	27,0	27,0	3300	220
1/2"	1/2"	UF 12 NPTF 12	55,4	2,18	26,4	10,2	0,40	27,0	27,0	3500	240

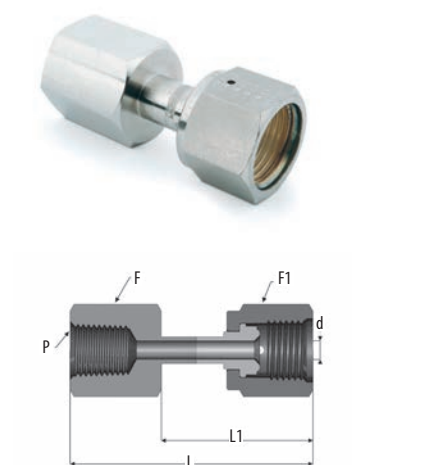

1) These fittings should be assembled only with rotating male or female nuts

UNIONS | TUBE FITTING MALE CONNECTOR

TUBE SIZE

T Tube O.D.	T1 Tube O.D.	Part number	L		L1	L2	d		F	F1	Working Pressure	
			mm	inch	mm	mm	mm	inch	mm	mm	psig	bar
FRACTIONAL												
1/4"	1/8"	UM 14 18 DB ¹	39,2	1,54	13,2	15,6	2,4	0,08	15,9	12	8000	550
1/4"	1/4"	UM 14 14 DB ¹	41,7	1,64	15,9	18,3	4,5	0,18	15,9	14	8000	550
1/2"	3/8"	UM 12 38 DB ¹	47	1,85	17,2	19,6	7,7	0,30	23,8	19	3500	240
1/2"	1/2"	UM 12 12 DB ¹	49,7	1,96	23,1	22,3	10,1	0,40	23,8	22	3500	240
METRIC												
1/4"	6 mm	UM 14 6M DB	41,3	1,63	15,5	17,9	4,5	0,18	15,9	14	6800	460
1/4"	8 mm	UM 14 8M DB	42,9	1,69	16,1	18,5	4,5	0,18	15,9	17	4800	330
1/2"	10 mm	UM 12 10M DB	46,7	1,84	16,9	19,3	8	0,32	23,8	19	3500	240

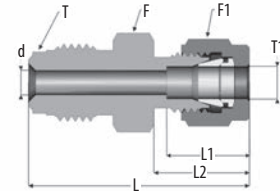

UNIONS | TUBE FITTING FEMALE CONNECTOR

TUBE SIZE

T1 Tube O.D.	T Tube O.D.	Part number	L		L1	L2	d		F	F1	F2	Working Pressure	
			mm	inch	mm	mm	mm	inch	mm	mm	mm	psig	bar
FRACTIONAL													
1/4"	1/4"	UF 14 14 DB	49,9	1,94	15,9	18,3	4,5	0,18	15,9	19,1	14	5100	350
1/2"	3/8"	UF 12 38 DB	50,0	1,97	17,2	19,6	7,1	0,28	23,8	27	19	3300	220
1/2"	1/2"	UF 12 12 DB	56,6	2,23	23,1	22,3	10,1	0,4	23,8	27	22	3500	240
METRIC													
1/4"	6 mm	UF 14 6M DB	49,3	1,94	15,7	18,0	4,5	0,18	14	19,1	14	5100	350
1/4"	8 mm	UF 14 8M DB	49,3	1,94	16,1	18,5	4,5	0,18	14	19,1	17	4800	330
1/2"	10 mm	UF 12 10M DB	56,6	2,23	16,9	19,3	8	0,31	17	27	19	3500	240
1/2"	12 mm	UF 12 12M DB	56,6	2,23	22,7	21,9	10,1	0,4	22	27	22	3100	210

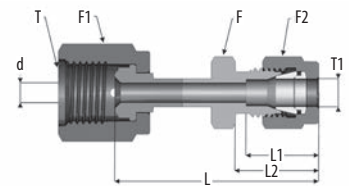

1) These fittings should be assembled only with rotating male or female nuts

BULKHEAD UNIONS | BULKHEAD NPT UNION

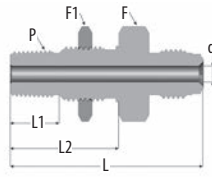

TUBE SIZE - FRACTIONAL

T Tube O.D.	P NPT	Part number	L		d		L1	L2	F	F1	Panel hole size	Max panel thickness	Working Pressure	
			mm	inch	mm	inch							mm	mm
1/4"	1/4"	BU 14 NPT 14 ¹	56,1	2,21	4,6	0,18	14,2	31,5	23,8	23,8	16,7	9,7	8000	550
1/2"	1/4"	BU 12 NPT 14 ¹	59,4	2,34	10,2	0,40	14,2	31,5	23,8	23,8	16,7	9,7	3500	240

¹⁾ These fittings should be assembled only with rotating male or female nuts

BULKHEAD UNIONS | TUBE FITTING BULKHEAD CONNECTOR

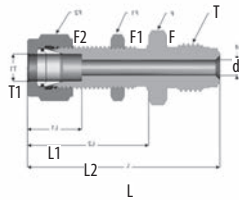

TUBE SIZE

T Tube O.D.	T1 Tube O.D.	Part number	L		L1	L2	d		F	F1	F2	Working Pressure	
			mm	inch			mm	inch				mm	mm
FRACTIONAL													
1/4"	1/4"	BU 14 14 DB ¹	57,2	2,25	15,2	33,5	4,6	0,18	19,1	19,1	14,3	5100	350
1/4"	1/4"	BUS 14 14 DB ¹	47,8	1,88	15,2	26,7	4,6	0,18	19,1	19,1	14,3	5100	350
1/2"	3/8"	BU 12 38 DB ¹	64,5	2,54	16,8	36,8	7,7	0,30	23,8	23,8	17,5	3300	220
1/2"	1/2"	BU 12 12 DB ¹	69,6	2,74	22,9	41,9	10,2	0,40	23,8	23,8	22,2	3500	240
METRIC													
1/4"	6 mm	BU 14 6M DB	57,3	2,26	15,5	33,6	4,5	0,18	19,1	17	14	6800	460
1/4"	8 mm	BU 14 8M DB	57,2	2,25	15,3	33,4	4,5	0,18	19,1	17	17	4800	330

¹⁾ These fittings should be assembled only with rotating male or female nuts

NUTS | FEMALE NUT FOR HIGH FLOW APPLICATIONS

TUBE SIZE - FRACTIONAL

T Tube O.D.	Part number	L		d		Thread size	F
		mm	inch	mm	inch		
3/8"	FN 14 HF	20,6	0,81	9,9	0,75	1/16" - 18	19,1

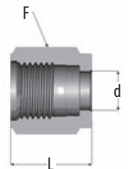

¹⁾ These fittings should be assembled only with rotating male or female nuts

NUTS | MALE NUT FOR HIGH FLOW APPLICATIONS

TUBE SIZE - FRACTIONAL

T Tube O.D.	Part number	L		d		Thread size	F
		mm	inch	mm	inch		
3/8"	MN 14 HF	18,3	0,72	9,9	0,39	9/16" - 18	17

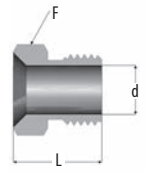

GLANDS | SHORT MALE GLAND FOR HIGH FLOW APPLICATIONS

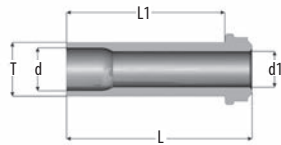

TUBE SIZE - FRACTIONAL

T Tube O.D.	Part number	L		L1		d1		d		Nominal Wall Thickness		Working Pressure	
		mm	inch	mm	inch	mm	inch	mm	inch	mm	inch	psig	bar
3/8"	EMC 14 38 HF	15,2	0,60	10,4	0,41	6,4	0,25	7,7	0,30	0,89	0,035	3300	220
3/8"	EMS 14 38 HF	30,2	1,19	25,4	1,00	6,4	0,25	7,7	0,30	0,89	0,035	3300	220
3/8"	EM 14 38 HF	33,3	1,31	28,4	1,12	6,4	0,25	7,7	0,30	0,89	0,035	3300	220

GLANDS | AUTOMATIC BUTTWELD BODY FOR HIGH FLOW APPLICATIONS

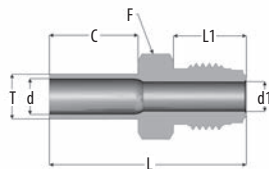

TUBE SIZE - FRACTIONAL

T Tube O.D.	Part number	L		L1	d1		d		C		F	Working Pressure	
		mm	inch	mm	mm	inch	mm	inch	mm	inch	mm	psig	bar
3/8"	UM 14 38 ABW HF	42,7	1,68	15,7	6,4	0,25	7,7	0,30	19,1	0,30	19,1	3300	220

GLANDS | AUTOMATIC BUTTWELD BODY FOR HIGH FLOW APPLICATIONS

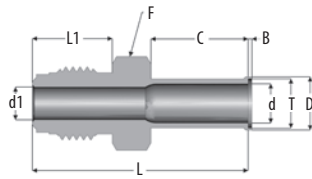

TUBE SIZE - FRACTIONAL

T Tube O.D.	Part number	L		L1	d1		d		D	B	C		F	Working Pressure	
		mm	inch	mm	mm	inch	mm	inch	mm	mm	mm	inch	mm	psig	bar
3/8"	UM 14 38 AB HF	43,4	1,71	15,7	6,4	0,25	7,7	0,30	10,5	0,8	19,1	0,75	15,7	3300	220

BULKHEAD UNIONS | BUTTWELD BULKHEAD UNION FOR HIGH FLOW APPLICATIONS

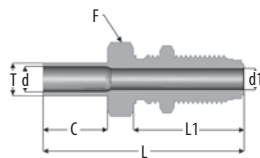

TUBE SIZE - FRACTIONAL

T Tube O.D.	Part number	L		L1	d1		d		C		F	F1	Panel Hole Size	Max Panel Thickness	Working Pressure	
		mm	inch	mm	mm	inch	mm	inch	mm	inch	mm	inch			psig	bar
3/8"	BU 14 38 HF	59,9	2,36	33,0	6,4	0,25	7,7	0,30	19,2	0,76	19	19	15,1	11,2	3300	220

UNIONS | EB-ABW

TUBE SIZE

T Tube O.D.	Part number	L		d		Working Pressure	
		mm	inch	mm	inch	psig	bar
FRACTIONAL							
1/4"	EB 14 ABW	4,8	0,19	4,5	0,18	5100	350
3/8"	EB 38 ABW	5,6	0,22	7,7	0,30	3300	220
1/2"	EB 12 ABW	6,9	0,27	10,1	0,40	3500	240
METRIC							
12 mm	13 mm	14 mm	15 mm	16 mm	17 mm	18 mm	19 mm

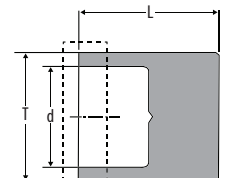

UNIONS | AUTOMATIC BUTTWELD REDUCING UNION WITHOUT SHOULDER

TUBE SIZE

T1 Tube O.D.	T Tube O.D.	Part number	L		d1		d		C		Working Pressure	
			mm	inch	mm	mm	mm	inch	psig	bar		
FRACTIONAL												
3/8"	1/4"	RU 38 14 ABW	38,1	1,50	7,7	4,6	19,1	0,75	3300	220		
1/2"	1/4"	RU 12 14 ABW	38,1	1,50	10,2	4,6	19,1	0,75	3500	240		
1/2"	3/8"	RU 12 38 ABW	38,1	1,50	10,2	7,7	19,1	0,75	3300	220		
3/4"	1/2"	RU 34 12 ABW	38,1	1,50	16,5	10,2	19,1	0,75	2400	160		
METRIC												
8 mm	6 mm	RU 8M 6M ABW	38,1	1,50	6,0	4,0	19,1	0,75	4800	330		
12 mm	6 mm	RU 12M 6M ABW	38,1	1,50	10,0	4,0	19,1	0,75	3100	210		
12 mm	8 mm	RU 12M 8M ABW	38,1	1,50	10,0	6,0	19,1	0,75	3100	210		
18 mm	6 mm	RU 18M 6M ABW	38,1	1,50	15,0	4,0	19,1	0,75	3100	210		
18 mm	12 mm	RU 18M 12M ABW	38,1	1,50	15,0	10,0	19,1	0,75	3100	210		
JIS												
3/8"	1/4"	RU 38J 14J ABW ¹	38,1	1,50	7,5	4,4	19,1	0,75	3500	240		
1/2"	1/4"	RU 12 14J ABW ¹	38,1	1,50	10,2	4,4	19,1	0,75	3500	240		
1/2"	3/8"	RU 12 38J ABW ¹	38,1	1,50	10,2	7,5	19,1	0,75	3500	240		

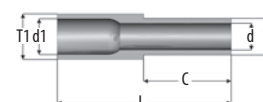

ELBOWS | AUTOMATIC BUTTWELD ELBOW WITHOUT SHOULDER

TUBE SIZE

T Tube O.D.	Part number	L		d		C		F	Working Pressure	
		mm	inch	mm	inch	mm	inch		psig	bar
FRACTIONAL										
1/4"	E 14 ABW	27,0	1,06	4,6	0,18	19,1	0,75	10	5100	350
1/4"	ECA 14 ABW	31,2	1,23	4,6	0,18	19,1	0,75	10	5100	350
3/8"	E 38 ABW	27,0	1,06	7,7	0,30	19,1	0,75	14	3300	220
3/8"	ECA 38 ABW	30,5	1,20	7,7	0,30	19,1	0,75	14	3300	220
1/2"	E 12 ABW	30,0	1,18	10,2	0,40	19,1	0,75	17	3500	240
1/2"	ECA 12 ABW	34,0	1,34	10,2	0,40	19,1	0,75	17	3500	240
3/4"	E 34 ABW	35,0	1,38	16,5	0,65	19,1	0,75	24	2400	160
1"	E 100 ABW	40,0	1,57	22,1	0,87	24,4	0,96	35	2400	160
METRIC										
6 mm	E 6M ABW	27,0	1,06	4,0	0,16	19,1	0,75	10	6800	460
8 mm	E 8M ABW	27,0	1,06	6,0	0,24	19,1	0,75	14	4800	330
10 mm	E 10M ABW	27,0	1,06	8,0	0,31	19,1	0,75	14	3500	240
12 mm	E 12M ABW	30,0	1,18	10,0	0,39	19,1	0,75	17	3100	210
JIS										
1/4"	E 14J ABW ¹	27,0	1,06	4,4	0,17	19,1	0,75	10	5600	380
3/8"	E 38J ABW ¹	27,0	1,06	7,5	0,29	19,1	0,75	14	3500	240

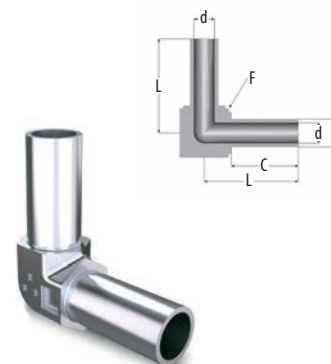

ELBOWS | AUTOMATIC BUTTWELD REDUCING ELBOW WITHOUT SHOULDER

TUBE SIZE

T1 Tube O.D.	T Tube O.D.	Part number	L		d1		d		C		F	Working Pressure	
			mm	inch	mm	inch	mm	inch	mm	inch		psig	bar
FRACTIONAL													
3/8"	1/4"	RE 38 14 ABW	27,0	1,06	7,7	0,30	4,6	0,18	19,1	0,75	14	3300	220
1/2"	1/4"	RE 12 14 ABW	30,0	1,18	10,2	0,40	4,6	0,18	19,1	0,75	17	3500	240
1/2"	3/8"	RE 12 38 ABW	30,0	1,18	10,2	0,40	7,7	0,30	19,1	0,75	17	3300	220
JIS													
3/8"	1/4"	RE 38J 14J ABW	27,0	1,06	7,5	0,29	4,4	0,17	19,1	0,75	14	3500	240
1/2"	1/4"	RE 12 14J ABW	30,0	1,18	10,2	0,40	4,4	0,17	19,1	0,75	17	3500	240
1/2"	3/8"	RE 12 38J ABW	30,0	1,18	10,2	0,40	7,5	0,29	19,1	0,75	17	3500	240

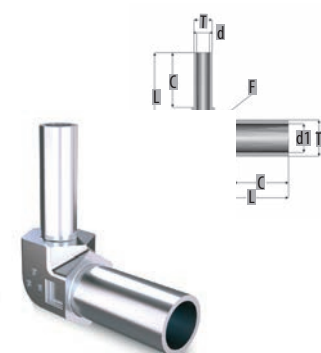

TEES | AUTOMATIC BUTTWELD TEE WITHOUT SHOULDER

TUBE SIZE

T Tube O.D.	Part number	L		d		C		F	Working Pressure	
		mm	inch	mm	inch	mm	inch		mm	psig
FRACTIONAL										
¼"	T 14 ABW	27,0	1,06	4,6	0,18	19,1	0,75	10	5100	350
¼"	TCA 14 ABW	31,2	1,23	4,6	0,18	19,1	0,75	10	5100	350
⅜"	T 38 ABW	27,0	1,06	7,7	0,30	19,1	0,75	14	3300	220
⅜"	TCA 38 ABW	30,5	1,20	7,7	0,30	19,1	0,75	14	3300	220
½"	T 12 ABW	30,0	1,18	10,2	0,40	19,1	0,75	17	3500	240
½"	TCA 12 ABW	34,0	1,34	10,2	0,40	19,1	0,75	17	3500	240
¾"	T 34 ABW	35,0	1,38	16,5	0,65	19,1	0,75	24	2400	160
1"	T 100 ABW	40,0	1,57	22,1	0,87	24,4	0,96	35	2400	160
METRIC										
6 mm	T 6M ABW	27,0	1,06	4,0	0,16	19,1	0,75	10	6800	460
6 mm	TCA 6M ABW	31,2	1,06	4,0	0,16	19,1	0,75	10	6800	460
8 mm	T 8M ABW	27,0	1,06	6,0	0,24	19,1	0,75	14	4800	330
10 mm	T 10M ABW	27,0	1,06	8,0	0,31	19,1	0,75	14	3500	240
12 mm	T 12M ABW	30,0	1,18	10,0	0,39	19,1	0,75	17	3100	210
12 mm	TCA 12M ABW	34,0	1,34	10,0	0,39	19,1	0,75	17	3100	210
JIS										
¼"	T 14J ABW ¹	27,0	1,06	4,4	0,17	19,1	0,75	10	5600	380
⅜"	T 38J ABW ¹	27,0	1,06	7,5	0,29	19,1	0,75	14	3500	240

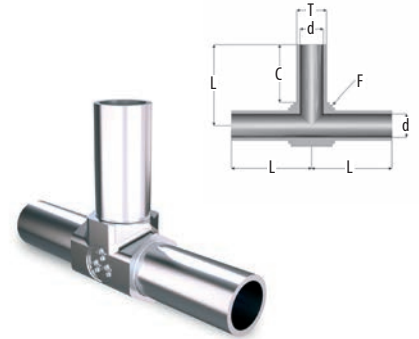

TEES | AUTOMATIC BUTTWELD REDUCING TEE WITHOUT SHOULDER

TUBE SIZE

T1 Tube O.D.	T Tube O.D.	Part number	L		d1		d		C		F	Working Pressure	
			mm	inch	mm	inch	mm	inch	mm	inch		mm	psig
FRACTIONAL													
⅜"	¼"	RT 38 14 ABW	27,0	1,06	7,7	0,30	4,6	0,18	19,1	0,75	14	3300	220
½"	¼"	RT 12 14 ABW	30,0	1,18	10,2	0,40	4,6	0,18	19,1	0,75	17	3500	240
½"	⅜"	RT 12 38 ABW	30,0	1,18	10,2	0,40	7,7	0,30	19,1	0,75	17	3300	220
METRIC													
8 mm	6 mm	RT 8M 6M ABW	27,0	1,06	6,0	0,24	4,0	0,16	19,1	0,75	14	4800	330
12 mm	6 mm	RT 12M 6M ABW	30,0	1,18	10,0	0,39	4,0	0,16	19,1	0,75	17	3100	210
12 mm	8 mm	RT 12M 8M ABW	30,0	1,18	10,0	0,39	6,0	0,24	19,1	0,75	17	3100	210
18 mm	6 mm	RT 18M 6M ABW	35,0	1,38	15,0	0,59	4,0	0,16	19,1	0,75	24	3000	200
18 mm	12 mm	RT 18M 12M ABW	35,0	1,38	15,0	0,59	10,0	0,39	19,1	0,75	24	3000	200
JIS													
⅜"	¼"	RE 38J 14J ABW ¹	27,0	1,06	7,5	0,29	4,4	0,17	19,1	0,75	14	3500	240
½"	¼"	RE 12 14J ABW ¹	30,0	1,18	10,2	0,40	4,4	0,17	19,1	0,75	17	3500	240
½"	⅜"	RE 12 38J ABW ¹	30,0	1,18	10,2	0,40	7,5	0,29	19,1	0,75	17	3500	240

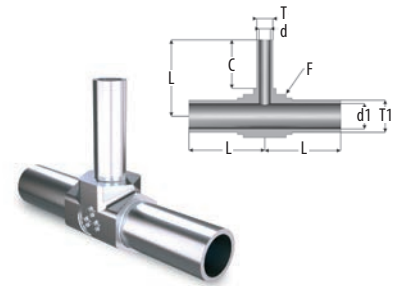

TEES | AUTOMATIC BUTTWELD CROSS WITHOUT SHOULDER

TUBE SIZE

T Tube O.D.	Part number	L		d		C		F	Working Pressure	
		mm	inch	mm	inch	mm	inch		mm	psig
FRACTIONAL										
¼"	C 14 ABW	27,0	1,06	4,6	0,18	19,1	0,75	10	5100	350
⅜"	C 38 ABW	27,0	1,06	7,7	0,30	19,1	0,75	14	3300	220
½"	C 12 ABW	30,0	1,18	10,2	0,40	19,1	0,75	17	3500	240
METRIC										
6 mm	C 6M ABW	27,0	1,06	4,0	0,16	19,1	0,75	10	6800	460
8 mm	C 8M ABW	27,0	1,06	6,0	0,24	19,1	0,75	14	4800	330
12 mm	C 12M ABW	30,0	1,18	10,0	0,39	19,1	0,75	17	3100	210

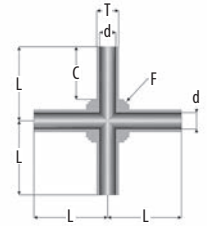

A FULL LINE OF GAS CONTROL SOLUTIONS



COMPLETE SOLUTIONS FROM SOURCE TO PROCESS.

ROTAREX is helping engineers worldwide to get better gas results: from ultra high purity production and medical care facilities to industrial and LPG applications, as well as alternative energy vehicles, fire suppression, diving, aerospace, cryogenics, laboratory, petro-chemical and welding. ROTAREX applies almost 100 years of know-how and experience to custom design, develop and manufacture the high performance valves, regulators and fittings to suit your needs, all in one hand. Discover the difference ROTAREX can make in your world.

CYLINDER VALVES

EQUIPMENT

FIRETEC

AUTOMOTIVE

LPG/SRG

MEDITEC



ULTRA HIGH PURITY VALVES



MEDICAL VALVES & EQUIPMENT



INDUSTRIAL CYLINDER VALVES



REFRIGERANT CYLINDER VALVES



PRESSURE REGULATORS



SUPPLY & SWITCH OVER BOARDS



LINE VALVES



FITTINGS & ADAPTORS



**FIXED INSTALLATION
FIRE SYSTEMS**



**OBJECT FIRE SUPPRESSION
SYSTEMS**



**AUTOMOTIVE VALVES
& REGULATORS**



WATER CARBONATION



**LPG TANK VALVES
& REGULATORS**



**LPG CYLINDER VALVES
& REGULATORS**



**DIGITAL MEASUREMENT
SYSTEMS**



PLASTIC INJECTION MouldING



WORLDWIDE HEADQUARTERS

ROTAREX S.A.
24, rue de Diekirch,
L-7440 Lintgen
Luxembourg
Tel.: +352 32 78 32-1
Fax: +352 32 78 32-854
E-mail: info@rotarex.com

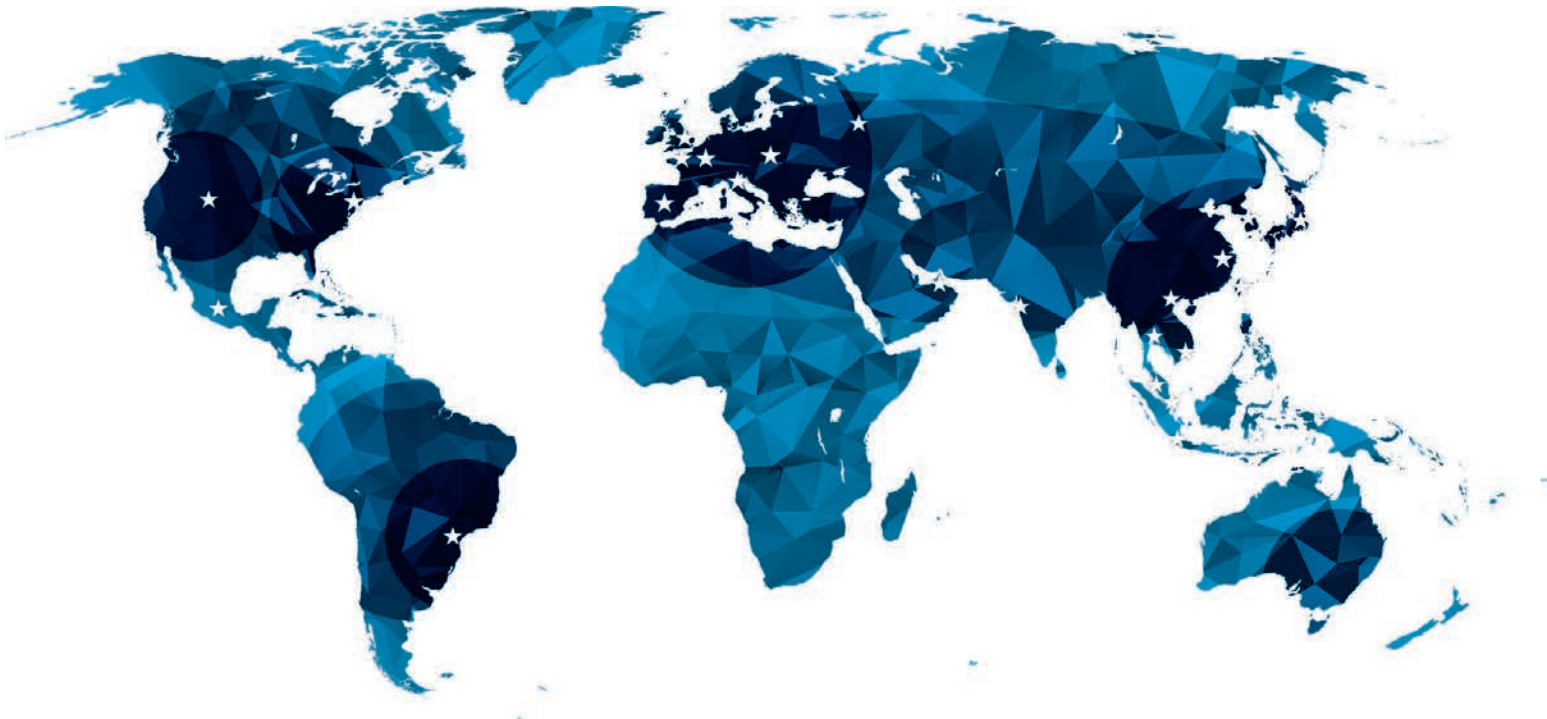

REGIONAL / COUNTRY HEADQUARTERS

NORTH AMERICA

USA
Rotarex North America
Hackettstown
E-mail: northamerica@rotarex.com

SOUTH AMERICA

BRASIL
Rotarex Brazil Ltda
São Paulo
E-mail: brasil@rotarex.com

CENTRAL AMERICA

MEXICO
Rotarex Mexico
Mexico City
E-mail: mexico@rotarex.com

EUROPE

EUROPEAN HEADQUARTERS
Rotarex S.A. Luxembourg
24, rue de Diekirch,
L-7440 Lintgen, Luxembourg
Tel.: +352 32 78 32-1
E-mail: salesequipment@rotarex.com

ITALY
Rotarex Italia S.r.l.
Ciliverghe di Mazzano
E-mail: italia@rotarex.com

SPAIN
Rotarex Spain
Madrid
E-mail: spain@rotarex.com

FRANCE
Rotarex France
Paris
E-mail: france@rotarex.com

GERMANY
Rotarex Germany
Gladenbach
E-mail: germany@rotarex.com

RUSSIA
Rotarex Russia
Moscow
E-mail: russia@rotarex.com

POLAND
Rotarex Polska
Brzeg
E-mail: polska@rotarex.com

UNITED KINGDOM
Rotarex UK Ltd.
London
E-mail: uk@rotarex.com

ASIA - PACIFIC

SINGAPORE
Rotarex Fareast Pte Ltd
Singapore
E-mail: fareast@rotarex.com

CHINA
Rotarex Star
Shanghai
E-mail: china@rotarex.com

JAPAN
Rotarex Japan Ltd
Tokyo
E-mail: japan@rotarex.com

INDIA
Rotarex ENGG. PVT. LTD.
Mumbai
E-mail: india@rotarex.com

SOUTH KOREA
Rotarex South Korea
Hwasung-si
E-mail: korea@rotarex.com

THAILAND
Rotarex (Thailand) Co Ltd.
Pakkret
E-mail: thailand@rotarex.com

TAIWAN
Rotarex Taiwan
Taipei
E-mail: info-taiwan@rotarex.com

MALAYSIA
Rotarex Malaysia
Kuala Lumpur
E-mail: malaysia@rotarex.com

PHILIPPINES
Rotarex Philippines
Manila
E-mail: philippines@rotarex.com

INDONESIA
Rotarex Indonesia
Jakarta
E-mail: Indonesia@rotarex.com

VIETNAM
Rotarex Vietnam
Hanoi
E-mail: vietnam@rotarex.com

MIDDLE EAST / AFRICA

MIDDLE EAST
Rotarex Middle East
Dubai
E-mail: middle-east@rotarex.com



For more contact details go to
www.rotarex.com/locations